

HARWIN

Datamate®

Panel Mount with Datamate

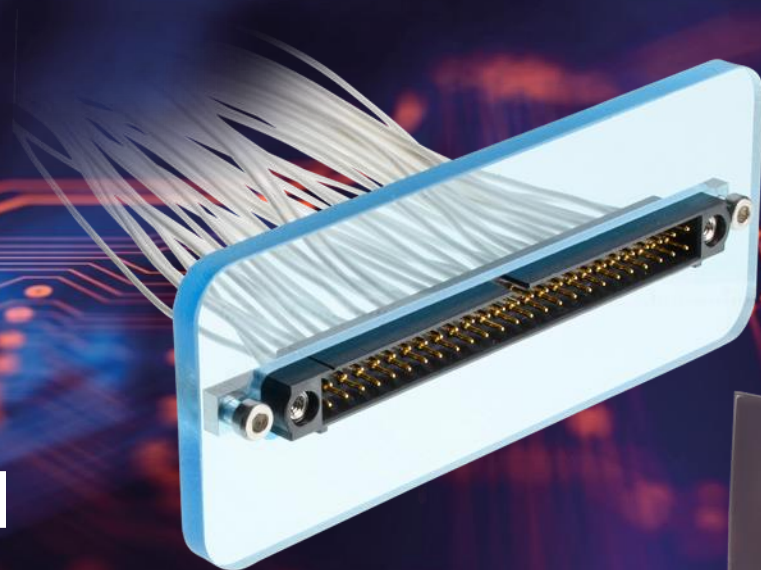

PANEL MOUNT WITH DATAMATE - CONTENTS

Section	Page
Introduction	3-4
Male Rear Panel Mount (Standard Gender jackscrews)	5
▪ Attaching to Panels	6
▪ Mating Female connectors, standard jackscrews	7
▪ Mating Female connectors with T-Contact	8
▪ Mating Female connectors with Extended Walls	9
▪ Mating Female connectors with Plastic Hoods	10
Male Front Panel Mount (Standard Gender jackscrews)	11
▪ Attaching to Panels	12
▪ Mating Female connectors, standard jackscrews	13
▪ Mating Female connectors with T-Contact	14
▪ Mating Female connectors with Extended Walls	15
▪ Mating Female connectors with Plastic Hoods	16

Section	Page
Female Front Panel Mount (Reverse Fix jackscrews)	17
▪ With T-Contact	18
▪ Mating Male connectors	19
Male Front Panel Mount with Metal Backshells	20
▪ Mating Female connectors	21
▪ Braiding	22
Panel to Panel Mount	
▪ Male Rear to Female Front	23
▪ Male Front to Female Front	24
Help from Harwin	25-27



WHAT IS PANEL MOUNT?

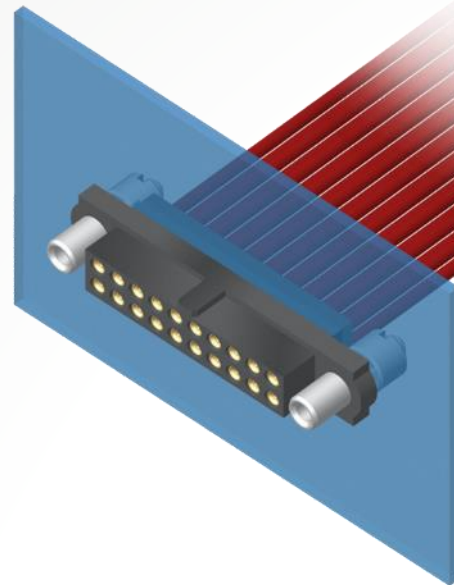

Panel Mount is a mechanical feature or features built into the design of a connector half. It allows the connector to be secured to an equipment panel, external case or enclosure. Often (but not always), connectors fitted with panel mount features will be cable connectors.

Read more information about panel mount on our [training blog post](#).

Datamate®

CAN I ACHIEVE PANEL MOUNT WITH DATAMATE?

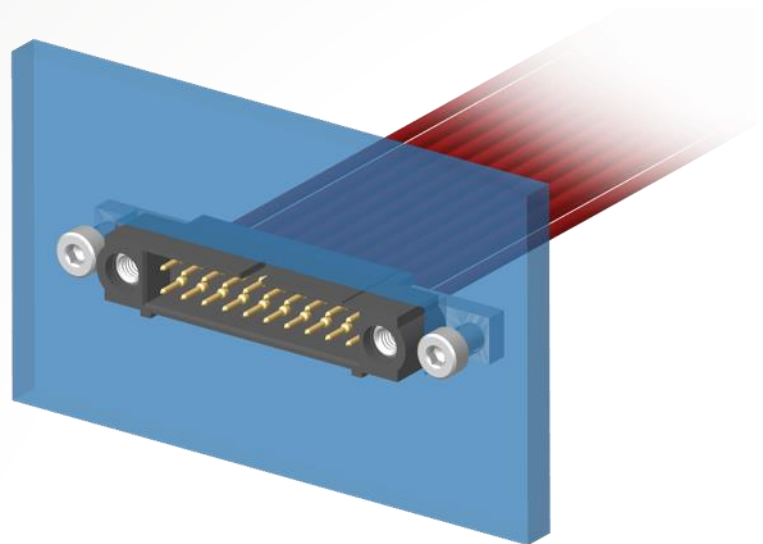
YES 

Yes, you can achieve both Front panel mounted and Rear panel mounted with [Datamate](#). This Training Module gives details and part numbers to help you choose the right combination for signal-only Datamate J-Tek connectors.

By choosing the same jackscrew configurations, these cable-to-panel connections can also be achieved with power, coax or mixed connections (Datamate Mix-Tek).

MALE REAR PANEL MOUNT – USING STANDARD GENDER

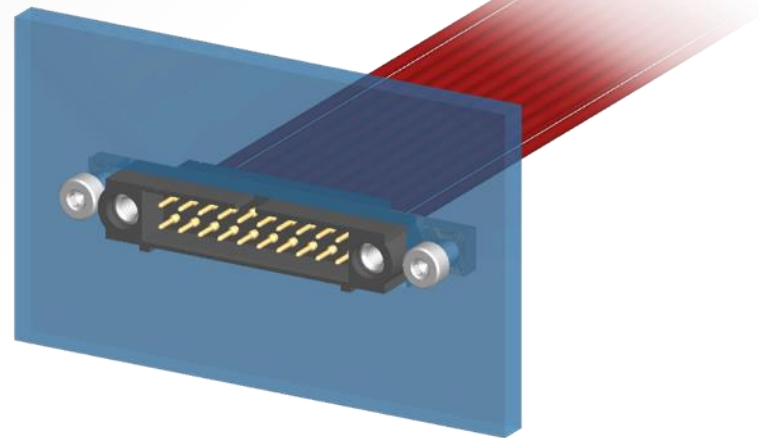
Rear Panel
Mount Male

Rear Panel Mount for the male cable connector uses standard gender jackscrews with extended lugs, giving additional M2 threaded fixings:

- Male Kit (with contacts for 24-28AWG) = M80-5C1XX05MU
- XX = Number of contacts: 04 to 50 (even numbers)
- Contact Finish is gold

MALE REAR PANEL MOUNT – USING STANDARD GENDER



M80-2320000B



M80-2270000B



To fix these connectors to your panel, the extended lugs already have internal threads. Just add M2 threaded bolts at the front of the panel.

- Ensure you specify adequate thread length on the bolt to pass through the panel and fasten to the jackscrew lug.
- For thinner panels (less than 3mm), our 5mm bolts will be suitable: [M80-2320000B](#) (hex socket head) or [M80-2270000B](#) (slotted head).
- Any bolt with a M2 x 0.4 thread can be used for thicker panels.

MALE REAR PANEL MOUNT – USING STANDARD GENDER

Mating Cable
Female

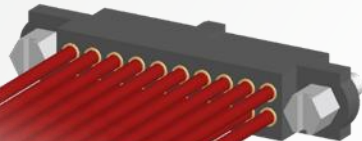

Rear Panel
Mount Male

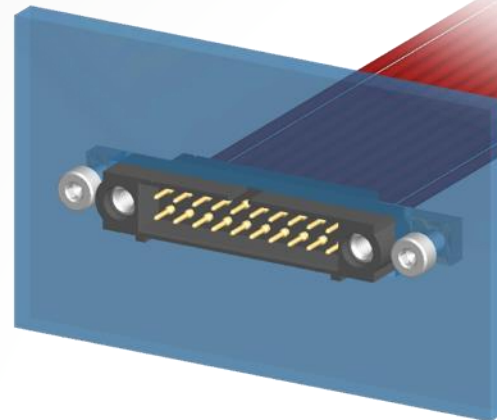

The mating Female connector requires standard gender floating jackscrews:

- Female Kit (with contacts for 22AWG) = [M80-460XXYY](#) (hex slotted jackscrews) or [M80-480XXYY](#) (hex socket)
- Female Kit (with contacts for 24-28AWG) = [M80-461XXYY](#) (hex slotted jackscrews) or [M80-481XXYY](#) (hex socket)
- XX = Number of contacts: 04, 06, 08, 10, 12, 14, 20, 26, 34, 42 or 50
- YY = Contact Finish: 05 for gold outer shells, 42 for tin outer shells (internal contact clip is always gold)

MALE REAR PANEL MOUNT – USING STANDARD GENDER

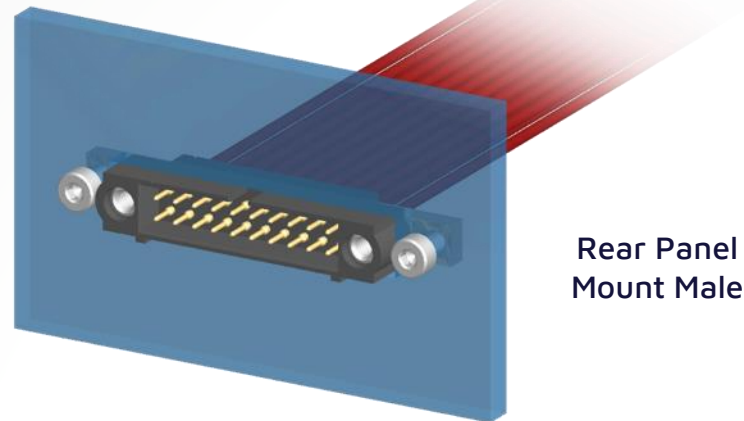
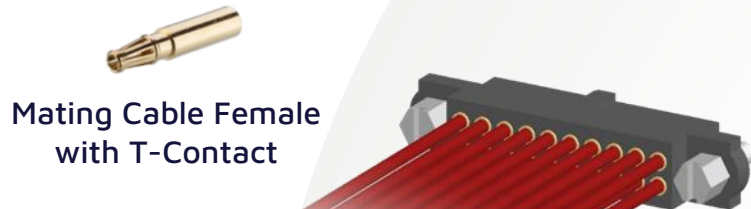

You can also specify the higher power T-Contact on the mating half, capable of up to 8.5A per contact:

- Female Housing = [M80-413XX98](#) (hex slotted jackscrews) or [M80-414XX98](#) (hex socket)
- XX = Number of contacts: 04 to 50 (even numbers)
- Female T-Contact (for 22AWG) = [M80-2060005](#) (gold), sold separately

MALE REAR PANEL MOUNT – USING STANDARD GENDER

Mating Cable Female
with Extended Walls

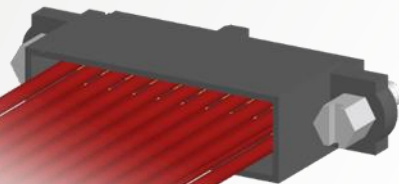

Rear Panel
Mount Male

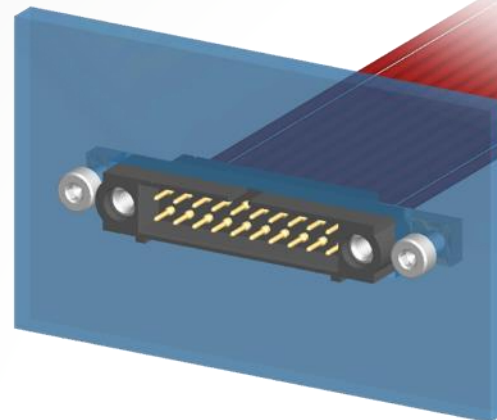

The mating Female connector with standard gender floating jackscrews can also have extended walls at the rear, for backpotting:

- Female Kit (with contacts for 22AWG) = [M80-465XXYY](#) (hex slotted jackscrews) or [M80-485XXYY](#) (hex socket)
- Female Kit (with contacts for 24-28AWG) = [M80-466XXYY](#) (hex slotted jackscrews) or [M80-486XXYY](#) (hex socket)
- XX = Number of contacts: 06, 10, 12, 14, 18, 20, 26, 34, 42 or 50
- YY = Contact Finish: 05 for gold outer shells, 42 for tin outer shells (internal contact clip is always gold)

MALE REAR PANEL MOUNT – USING STANDARD GENDER

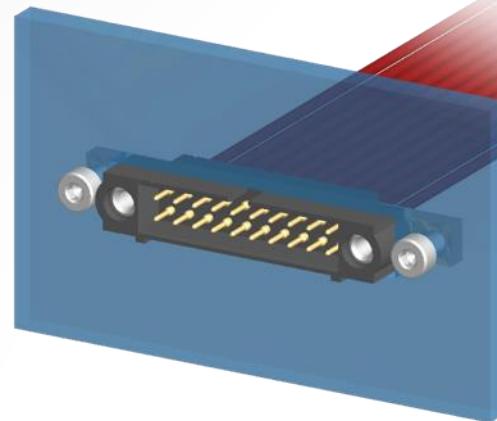
Mating Cable Female
with Plastic HoodsRear Panel
Mount Male

The full kit with Plastic Hoods is also compatible as a mating connector, and comes with slotted floating jackscrews:

- Female Kit (with contacts for 22AWG) = [M80-941XXYY](#)
- Female Kit (with contacts for 24-28AWG) = [M80-940XXYY](#)
- XX = Number of contacts: 06, 08, 10, 12, 14, 20, 26, 34, 42 or 50
- YY = Contact Finish: 05 for gold outer shells, 42 for tin outer shells (internal contact clip is always gold)

MALE FRONT PANEL MOUNT – USING STANDARD GENDER

Front Panel
Mount Male

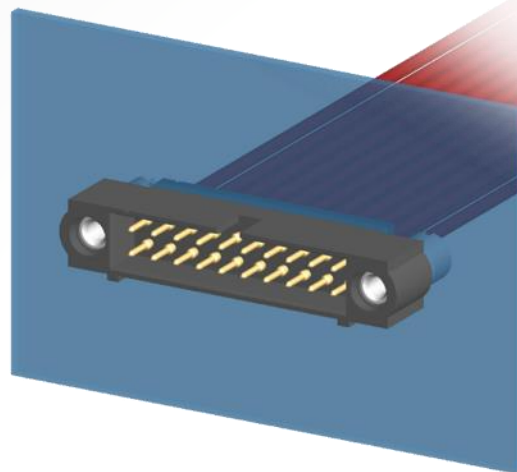

Front Panel Mount for the male cable connector uses the same standard gender jackscrews as board mount for PCB connectors:

- Male Kit (with contacts for 22AWG) = M80-5D1XX05M2 (for 3.5mm panel mount studs) or M80-5D1XX05M3 (5mm)
- Male Kit (with contacts for 24-28AWG) = M80-5C1XX05M2 (for 3.5mm panel mount studs) or M80-5C1XX05M3 (5mm)
- XX = Number of contacts: 04, 06, 08, 10, 12, 14, 20, 26, 34, 42 or 50
- Contact Finish is gold

MALE FRONT PANEL MOUNT – USING STANDARD GENDER



M80-2130000B
(included)

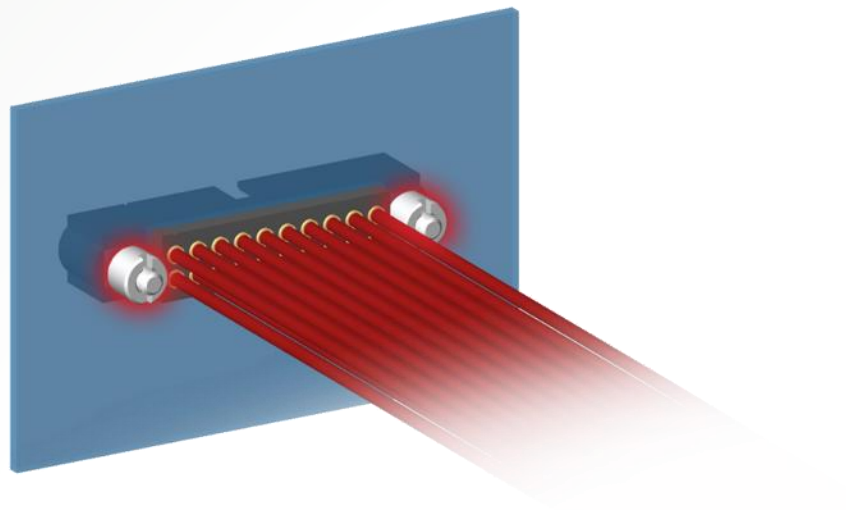

To fix these connectors to your panel, the connector has rear studs, externally threaded to M2 x 0.4. These pass through the panel and are secured with nuts at the rear face of the panel.

These M2 slotted nuts are included with the connector kits listed on the previous page. Spares can be ordered – part number [M80-2130000B](#).

MALE FRONT PANEL MOUNT – USING STANDARD GENDER

Mating Cable
Female

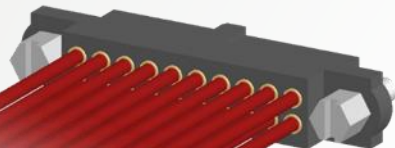

Front Panel
Mount Male

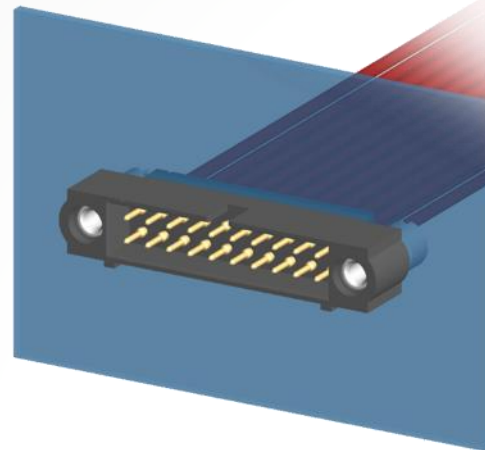

The mating Female connector is the same as mating with the Rear Panel Mount, requiring standard gender floating jackscrews:

- Female Kit (with contacts for 22AWG) = [M80-460XXYY](#) (hex slotted jackscrews) or [M80-480XXYY](#) (hex socket)
- Female Kit (with contacts for 24-28AWG) = [M80-461XXYY](#) (hex slotted jackscrews) or [M80-481XXYY](#) (hex socket)
- XX = Number of contacts: 04, 06, 08, 10, 12, 14, 20, 26, 34, 42 or 50
- YY = Contact Finish: 05 for gold outer shells, 42 for tin outer shells (internal contact clip is always gold)

MALE FRONT PANEL MOUNT – USING STANDARD GENDER

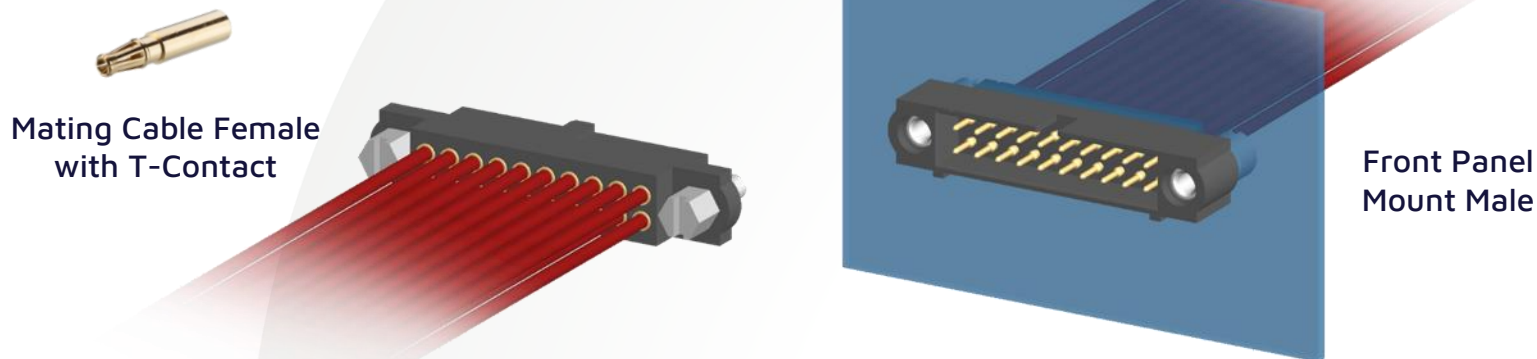

You can also specify the higher power T-Contact on the mating half, capable of up to 8.5A per contact:

- Female Housing = [M80-413XX98](#) (hex slotted jackscrews) or [M80-414XX98](#) (hex socket)
- XX = Number of contacts: 04 to 50 (even numbers)
- Female T-Contact (for 22AWG) = [M80-2060005](#) (gold), sold separately

MALE FRONT PANEL MOUNT – USING STANDARD GENDER

Mating Cable Female
with Extended Walls

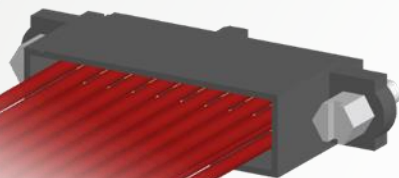

Front Panel
Mount Male

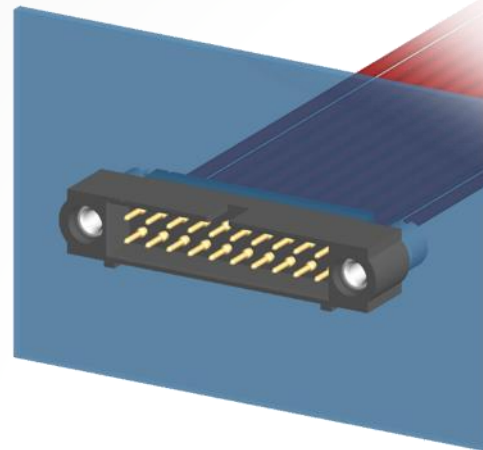

The mating Female connector with standard gender floating jackscrews can also have extended walls at the rear, for backpotting:

- Female Kit (with contacts for 22AWG) = [M80-465XXYY](#) (hex slotted jackscrews) or [M80-485XXYY](#) (hex socket)
- Female Kit (with contacts for 24-28AWG) = [M80-466XXYY](#) (hex slotted jackscrews) or [M80-486XXYY](#) (hex socket)
- XX = Number of contacts: 06, 10, 12, 14, 18, 20, 26, 34, 42 or 50
- YY = Contact Finish: 05 for gold outer shells, 42 for tin outer shells (internal contact clip is always gold)

MALE FRONT PANEL MOUNT – USING STANDARD GENDER

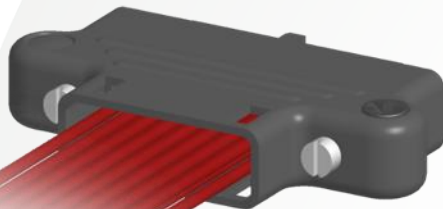
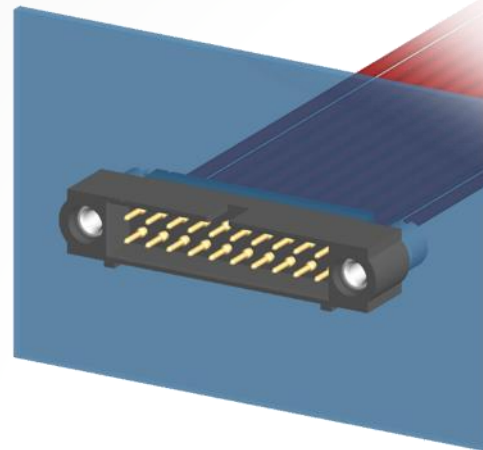
Mating Cable Female
with Plastic HoodsFront Panel
Mount Male

The full kit with Plastic Hoods is again compatible as a mating connector, and comes with slotted floating jackscrews:

- Female Kit (with contacts for 22AWG) = [M80-941XXYY](#)
- Female Kit (with contacts for 24-28AWG) = [M80-940XXYY](#)
- XX = Number of contacts: 06, 08, 10, 12, 14, 20, 26, 34, 42 or 50
- YY = Contact Finish: 05 for gold outer shells, 42 for tin outer shells (internal contact clip is always gold)

FEMALE FRONT PANEL MOUNT – USING REVERSE FIX

Panel Mount
Female

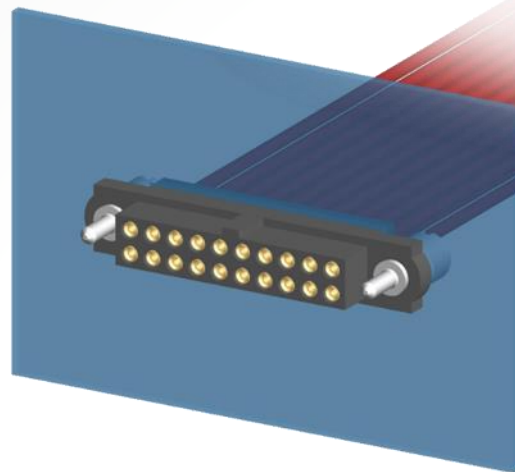

Using the female reverse fix jackscrews, the female connector is mounted using the same method as the front panel male (see [page 12](#)):

- Female Kit (with contacts for 22AWG) = [M80-462XXYY](#) (for 3.5mm panel mount studs) or M80-4D1XXYYF9 (5mm)
- Female Kit (with contacts for 24-28AWG) = [M80-463XXYY](#) (for 3.5mm panel mount studs) or M80-4C1XXYYF9 (5mm)
- XX = Number of contacts: 04, 06, 08, 10, 12, 14, 20, 26, 34, 42 or 50
- YY = Contact Finish: 05 for gold outer shells, 42 for tin outer shells (internal contact clip is always gold)

FEMALE FRONT PANEL MOUNT – USING REVERSE FIX



Panel Mount Female
with T-Contact

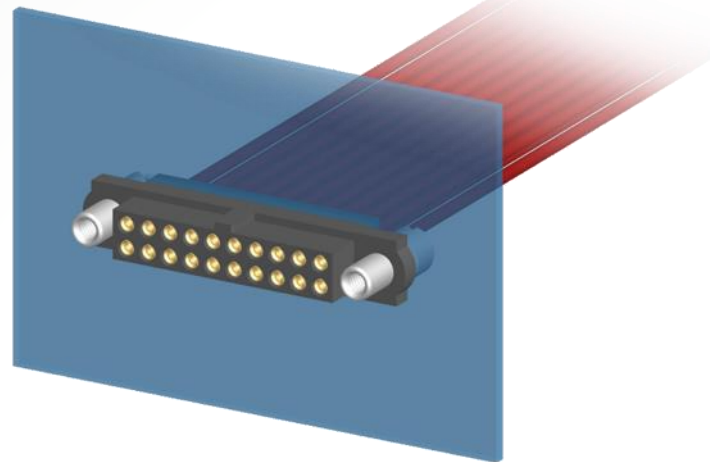

You can also specify the same housing & jackscrew style, and use the T-Contact for higher current capacity (up to 8.5A per contact):

- Female Housing = [M80-415XX98](#) (with 3.5mm panel mount studs)
- Female T-Contact (for 22AWG) = [M80-2060005](#) (gold), sold separately
- XX = Number of contacts: 04 to 50 (even numbers)

FEMALE FRONT PANEL MOUNT – USING REVERSE FIX

Mating Cable
Male

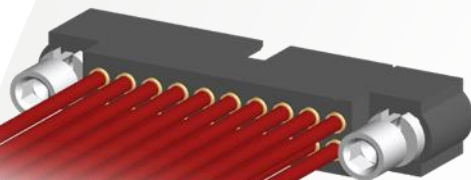

Panel Mount
Female

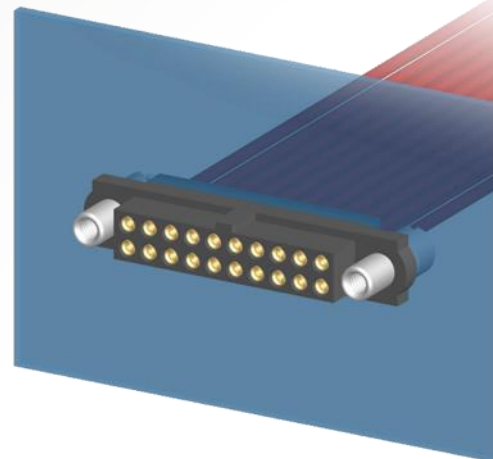

The mating Male connector (compatible with both standard and T-Contact female) also requires reverse fix jackscrews:

- Male Kit (with contacts for 22AWG) = [M80-562XX05](#) (for slotted jackscrews) or [M80-582XX05](#) (for hex socket)
- Male Kit (with contacts for 24-28AWG) = [M80-563XX05](#) (for slotted jackscrews) or [M80-583XX05](#) (for hex socket)
- XX = Number of contacts: 04, 06, 08, 10, 12, 14, 20, 26, 34, 42 or 50
- Contact Finish is gold

MALE FRONT PANEL MOUNT – USING METAL BACKSHELLS

Panel Mount Male with Metal Backshells

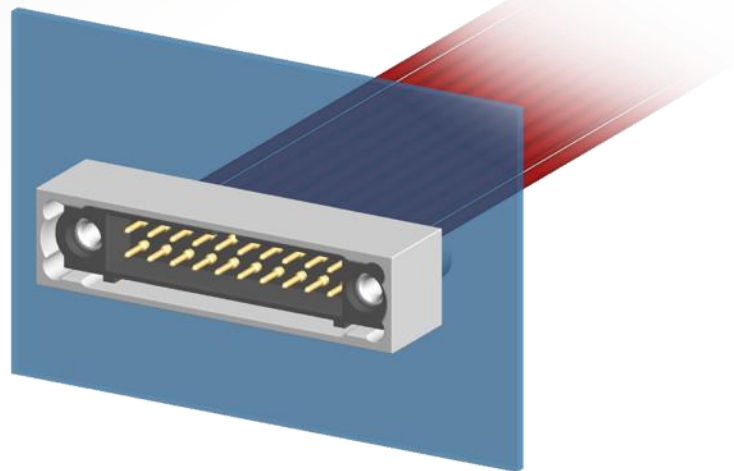

You can add metal backshells to the connection, for additional durability or shielding (mounted the same as the front panel male on [page 12](#)):

- Male connector Kit = M80-5D1XX05M3 (22AWG contacts) or M80-5C1XX05M3 (24-28AWG)
- Panel Mount backshell = [M80-906XX02](#)
- XX = Number of contacts: 08, 10, 12, 14, 16, 20, 22, 24, 26, 28 or 32
- Contact Finish is gold

MALE FRONT PANEL MOUNT – USING METAL BACKSHELLS

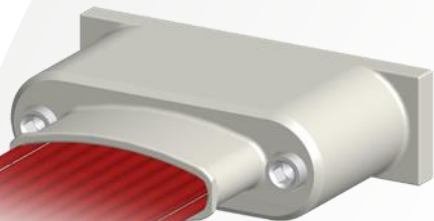
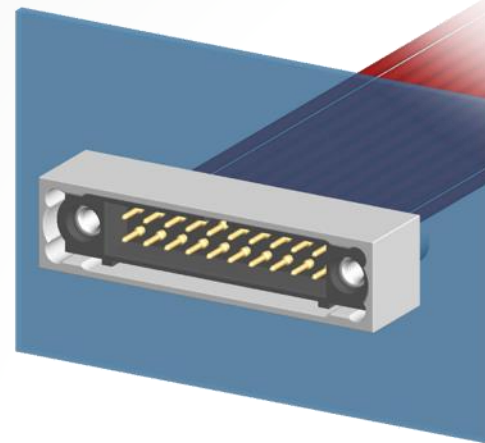
Mating Cable Female
with Metal BackshellsPanel Mount Male
with Metal Backshells

The mating cable metal backshell kit comes with the applicable longer jackscrews; use tool [Z80-300](#) to fit the circlips:

- Female connector Kit = [M80-470XXYY](#) (22AWG contacts) or [M80-471XXYY](#) (24-28AWG)
- Cable backshell = [M80-945XXO2](#) (slotted jackscrews) or [M80-946XXO2](#) (hex socket)
- XX = Number of contacts: 08, 10, 12, 14, 16, 20, 22, 24, 26, 28 or 32
- YY = Contact Finish: 05 for gold outer shells, 42 for tin outer shells (internal contact clip is always gold)

MALE FRONT PANEL MOUNT – USING METAL BACKSHELLS

Add Metal Braiding
for full shielding



Add Plastic Braiding for
durability, protection

To complete the full shielding effect, use braiding on the external cable assembly to shield the wires. The braid can be attached to the rear collar of the cable metal backshell. Alternatively, affix plastic braiding just for added durability and cable protection.

- BAND-IT Ties = [M80-9470000](#) (206.8mm) or [M80-9480000](#) (362mm) – use with applicable BAND-IT tooling
- Plastic Cable ties (not available from Harwin)

PANEL TO PANEL MOUNT WITH MALE REAR PANEL

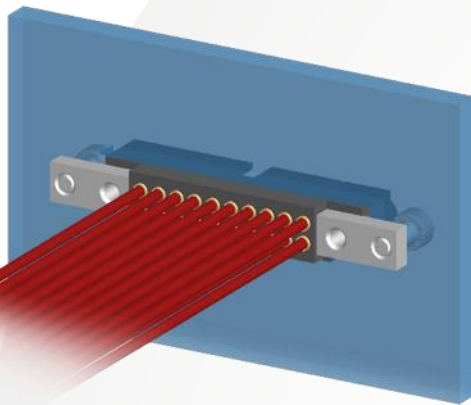
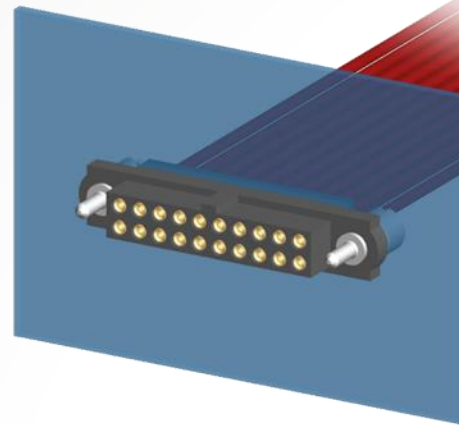
Rear Panel
Mount MalePanel Mount Female
with Guide Pins

This combination uses the male rear panel mount design and a front panel mount female connector with guide pins. There is no screw fixing between the two connectors, as it is unlikely that there would be any access available. Use the male connector from [page 5](#), and mate to:

- Female connector Kit = M80-4D1XXYYF3 (22AWG contacts) or M80-4C1XXYYF3 (24-28AWG)
- XX = Number of contacts: 04, 06, 08, 10, 12, 14, 20, 26, 34, 42 or 50
- YY = Contact Finish: 05 for gold outer shells, 42 for tin outer shells (internal contact clip is always gold)

PANEL TO PANEL MOUNT WITH MALE FRONT PANEL

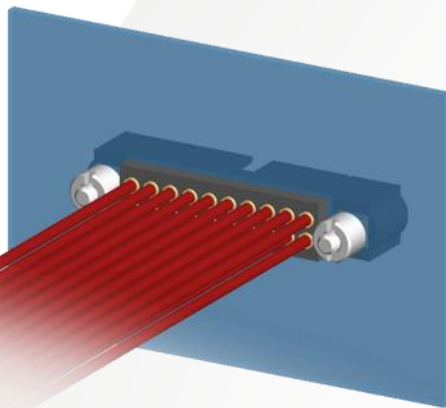
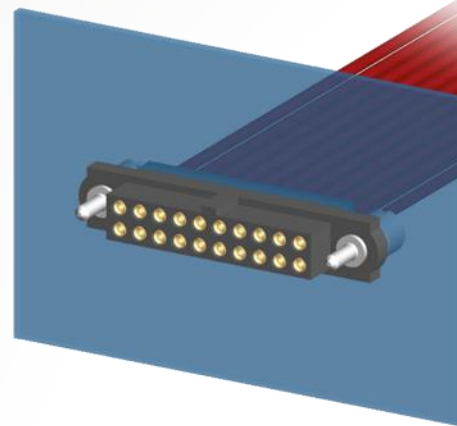
Front Panel
Mount MalePanel Mount Female
with Guide Pins

In this style, both male and female connectors are front panel mounted. This connection also has no screw fixing between the two connectors, with guide pins on the female. Use the male connector from [page 11](#), and mate to the same female style as shown on the previous page:

- Female connector Kit = M80-4D1XXYYF3 (22AWG contacts) or M80-4C1XXYYF3 (24-28AWG)
- XX = Number of contacts: 04, 06, 08, 10, 12, 14, 20, 26, 34, 42 or 50
- YY = Contact Finish: 05 for gold outer shells, 42 for tin outer shells (internal contact clip is always gold)

CONSIDERATIONS



When specifying connectors from this Training Module, please consider:

- Not all connector variations will be stocked, some will be made-to-order – please check availability in advance of your production requirements.
- We supply some full cable assemblies as standard, but we can also manufacture a wide range of cable assemblies to order, including braided, labelled, twisted pairs, and a variety of wire insulation colors. [Contact us](#) for help!

Learn more about our other ranges



HIGH RELIABILITY
WITH SUPREME
PERFORMANCE



INNOVATIVE
DESIGNS FOR
EASY ASSEMBLY



DEPENDABLE
CONNECTIVITY
ACROSS THE BOARD

Find out more about our full range
of inter-connection solutions at

www.harwin.com

HRi
RANGE

EZi
RANGE

BBi
RANGE

Get Help from a Harwin Expert

Our experts are specialists in their field with many years of experience in their respective roles and industries.

Find an expert that can help you with your enquiry.

[Click Here >>](#)

CAD Models and Evaluation Samples also available at www.harwin.com



Contact Us

Europe, Middle East & Africa

T: +44 (0)23 9231 4545

E: technical@harwin.com

Americas

T: +1 603 893 5376

E: technical-us@harwin.com

Asia Pacific

T: +65 6 779 4909

E: technical-asia@harwin.com

WWW.HARWIN.COM